



COMPETITOR SERIES®



C-RB24



C-RB36



C-RB48

RADIANT BROILERS

- Reversible heavy duty cast iron cooking grates with angled sides for flat or sloped positions
- Manually controlled cooking zones
- 35,000 BTU per “U” shape burner
- Removable, full width slide out waste tray
- Beautiful ergonomic design and easy to clean
- High polished, stainless steel exterior and chrome temperature knobs
- (4) adjustable stainless steel feet
- Comes standard as Natural Gas with L.P orifice kit for in-field conversion
- Migali Industries® Protection Plan: 2 Year Parts & Labor Warranty

MODEL	BURNERS	TOTAL BTU NG / LP	BTU PER BURNER - NG / LP	IN TAKE TUBE PRES- SURE (W.C.) NG / LP	NOZZLE NO. NG / LP	IGNITION	VALVE TYPE	WORKING AREA W X D	EXTERIOR DIMENSIONS W X D X H	PACKAGING DIMENSIONS W X D X H	WEIGHT	PACKAGED WEIGHT
C-RB24	2	70,000	35,000	4 /10	#36 / #50	Manual	Pilot Light	23.9 x 20.2	24 x 27.6 x 15.2	26.8 x 29.9 x 18.2	114 lbs.	147 lbs.
C-RB36	3	105,000	35,000	4 /10	#36 / #50	Manual	Pilot Light	35.7 x 20.2	36 x 27.6 x 15.2	38.6 x 29.9 x 18.2	161 lbs.	205 lbs.
C-RB48	4	140,000	35,000	4 /10	#36 / #50	Manual	Pilot Light	47.9 x 20.2	48 x 27.6 x 15.2	50.8 x 29.9 x 18.2	205 lbs.	257 lbs.

Gas Connection: 3/4" NPT on the right

Clearance for combustible work area: 6" rear & 15" sides - Do Not Store Combustibles Underneath Unit

NOTE: Altitudes over 2,000 feet may need high latitude orifice adjustments to deliver BTU output listed

FOR COMMERCIAL USE ONLY

NOTE: MIGALI® RESERVES THE RIGHT TO CHANGE SPECIFICATIONS WITHOUT NOTICE



TOLL FREE: 800.852.5292
WEB: www.migali.com



DIMENSIONAL DRAWINGS

C-RB24

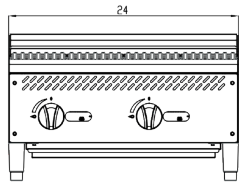

C-RB36

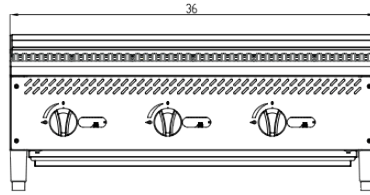

C-RB48

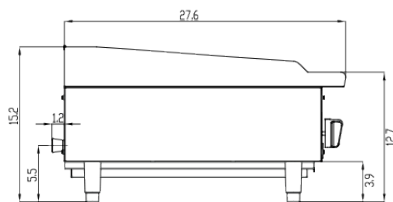
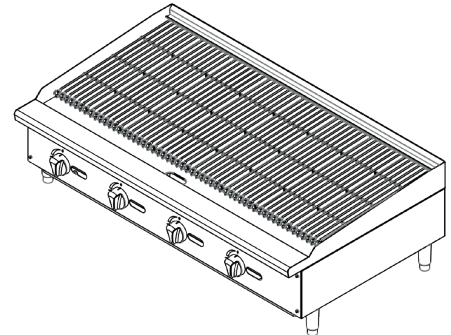
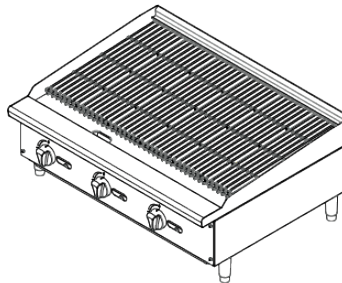
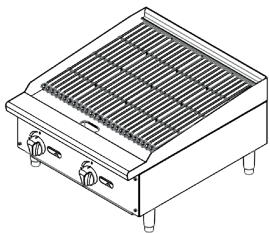
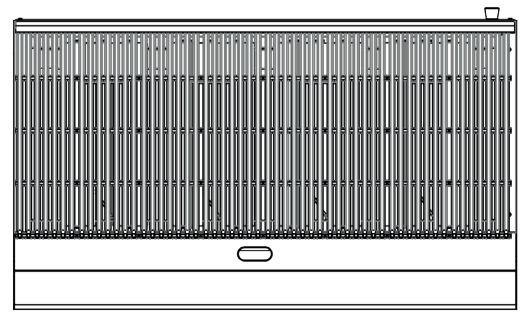
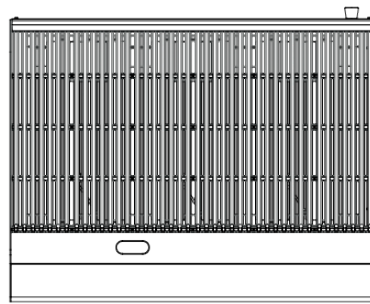
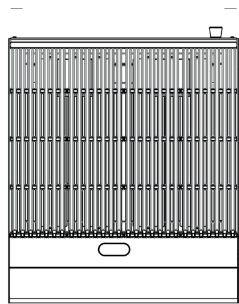
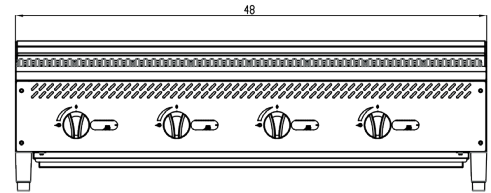

SIDE VIEW



MIGALI® REMAINS AN AMERICAN FAMILY COMPANY SINCE 1955